

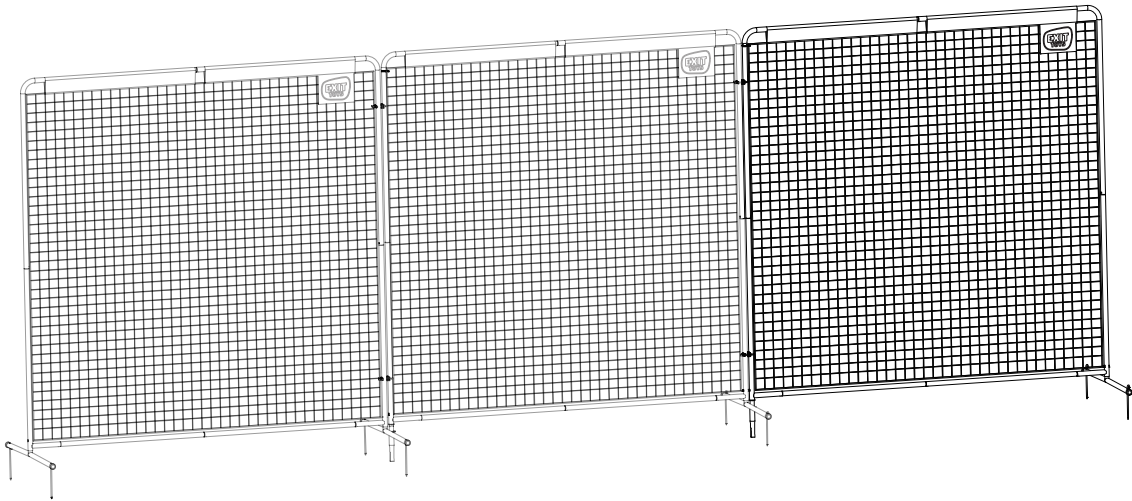

# Sports

EXIT Backstop Net 900



 **WARNING**  
CHOKING HAZARD  
small parts  
Adult assembly required  
retain for future reference





## EXIT Backstop Net 900

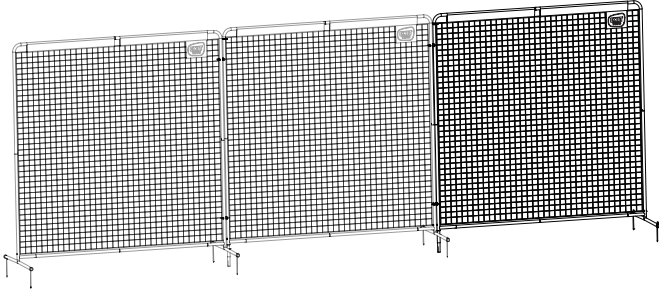

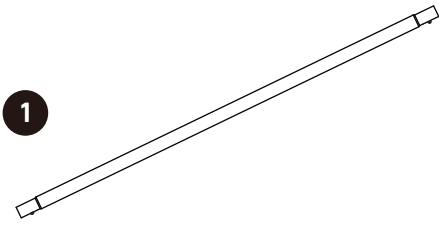

69.49.60.01 **2X**

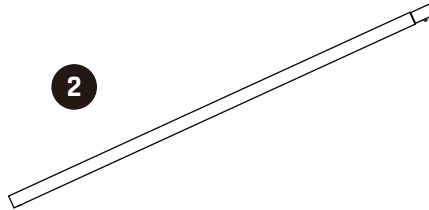

69.49.60.02 **2X**

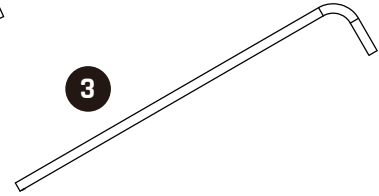

69.49.60.03 **2X**

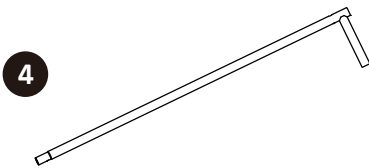

69.49.60.04 **2X**

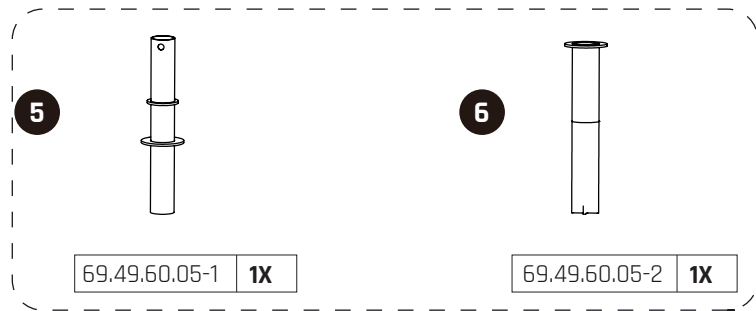

69.49.60.05-1 **1X**

69.49.60.05-2 **1X**

69.49.60.05

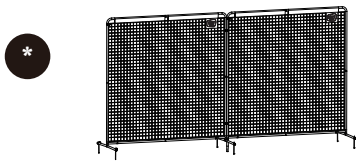

49.60.12.00 **1X**

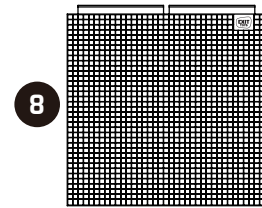

66.49.60.00 **1X**



69.49.60.09 **43X**

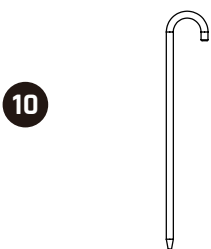

69.49.60.10 **2X**

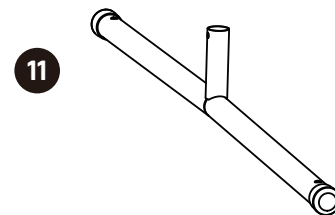

69.49.60.11 **1X**

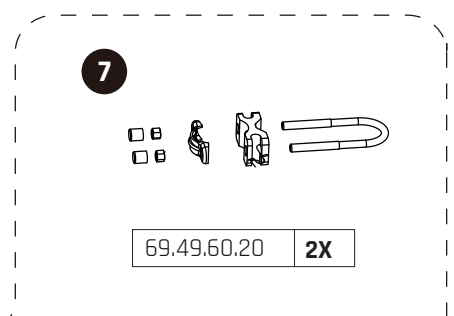

69.49.60.20 **2X**

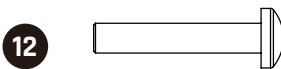

M8x45 **1X**



M8 **1X**



M8 **1X**



C0906000011 **1X**



66.04.99.15 **1X**

69.49.60.20

**1**

Part.Nr.	Qty
1	2
2	2

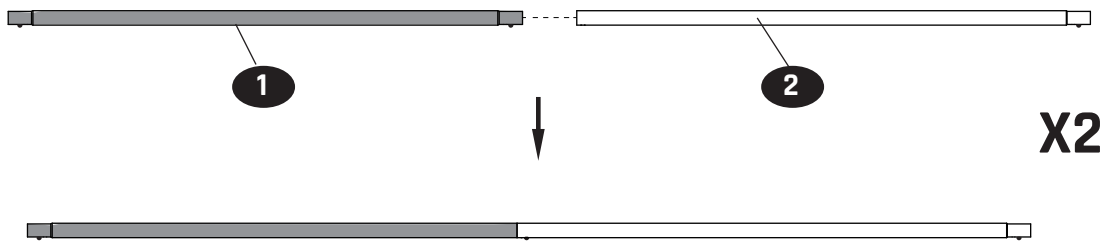

**2**

Part.Nr.	Qty
8	1

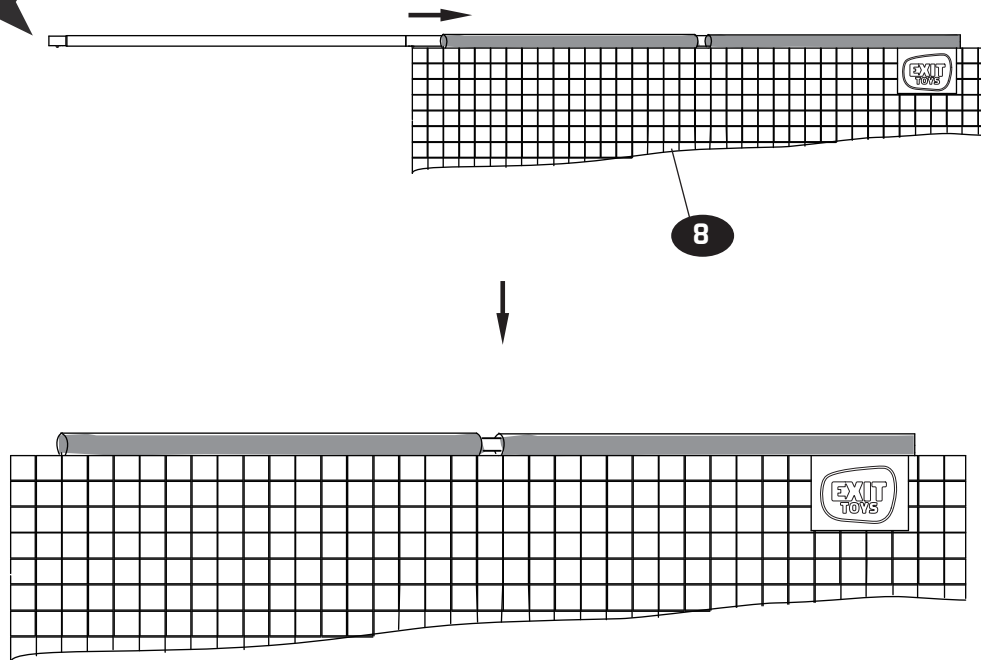

# Sports

EXIT Backstop Net 900

3

Part.Nr.	Qty
3	2

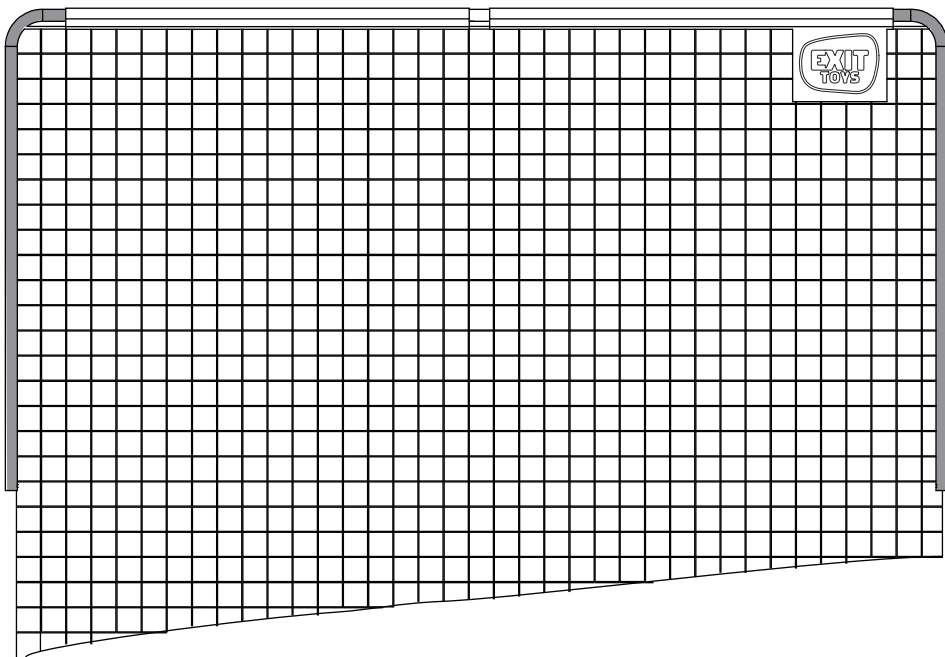
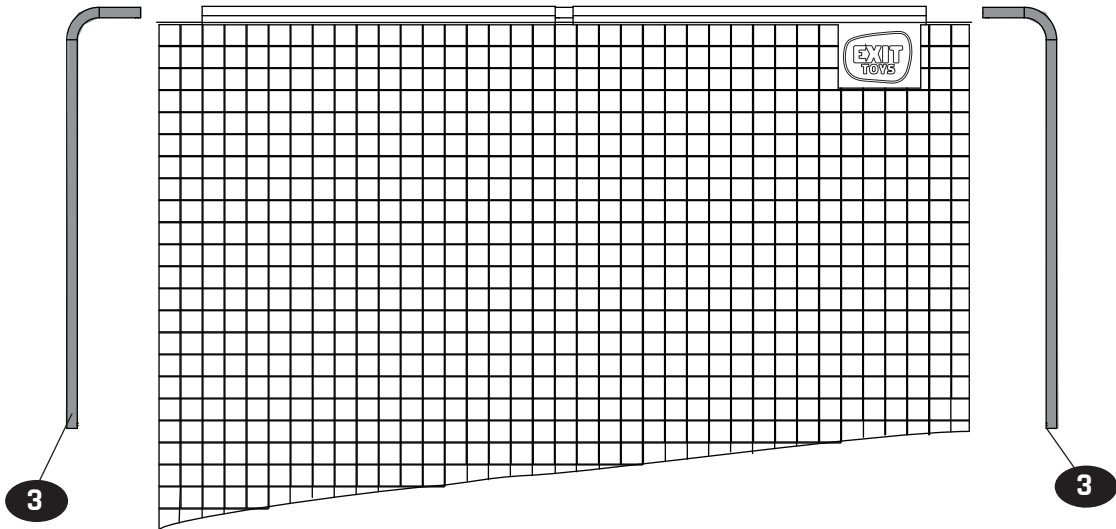

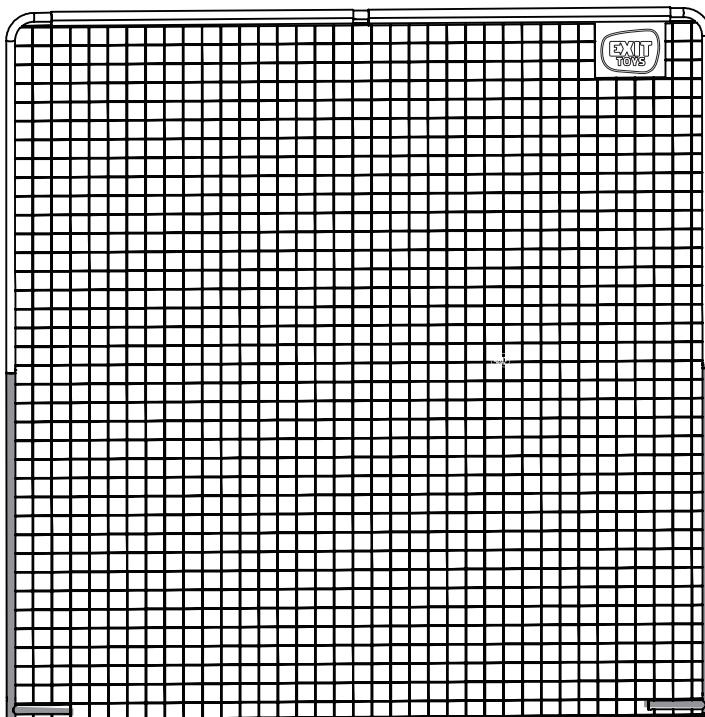
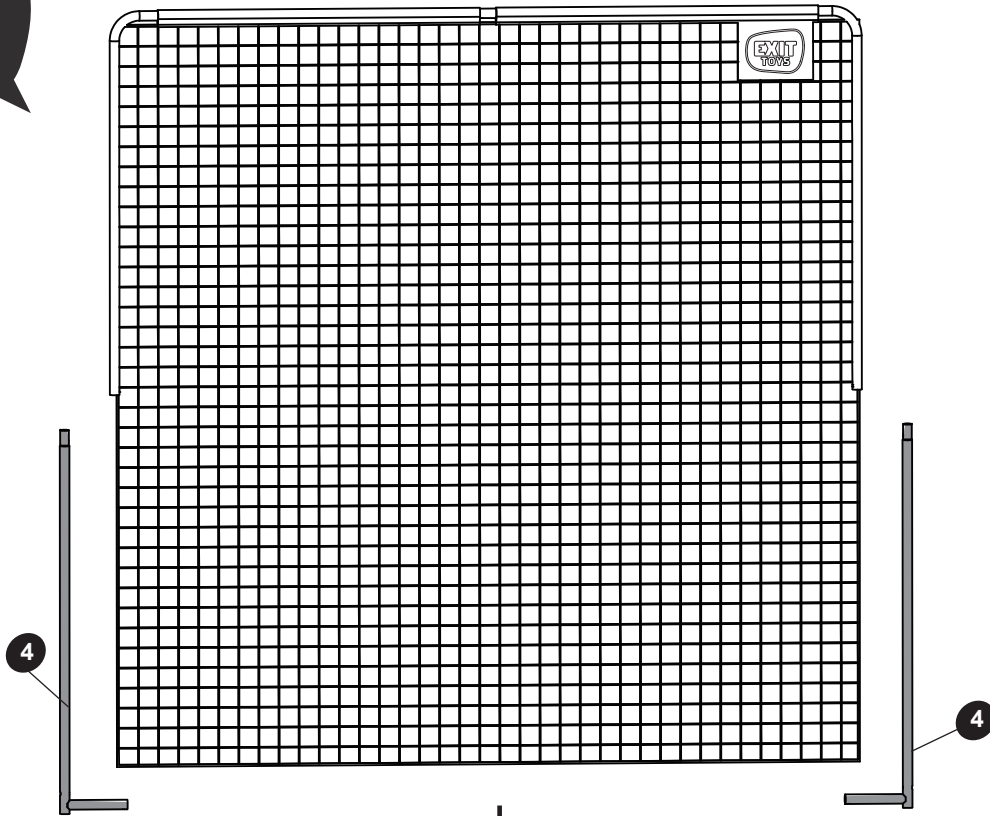

**4**

Part.Nr.	Qty
4	2

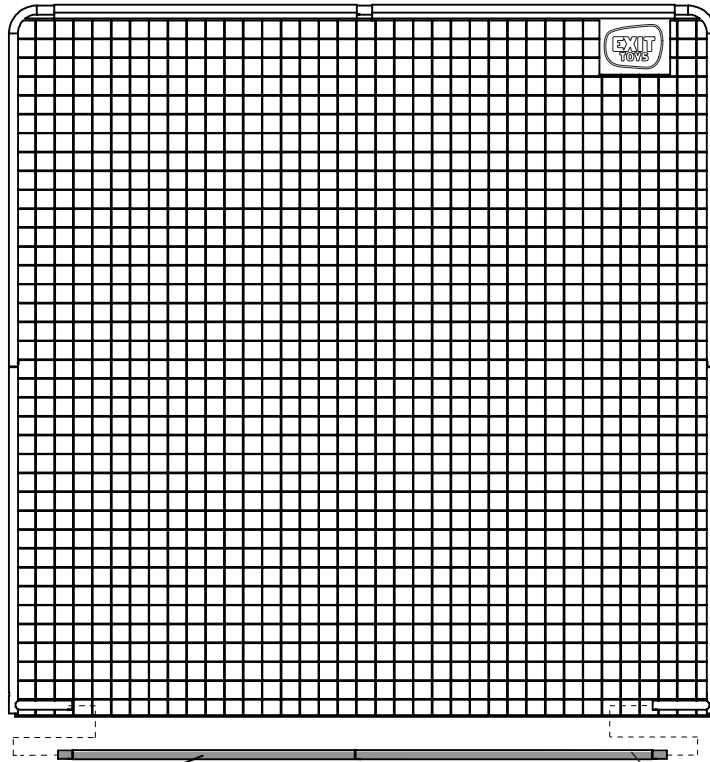

5



	ITEM REFERENCE:	49.60.12.00 2/2
	PRODUCTION ID:	

Step 1 / Schritt 1 / Stap 1 / Étape 1 / Trin 1

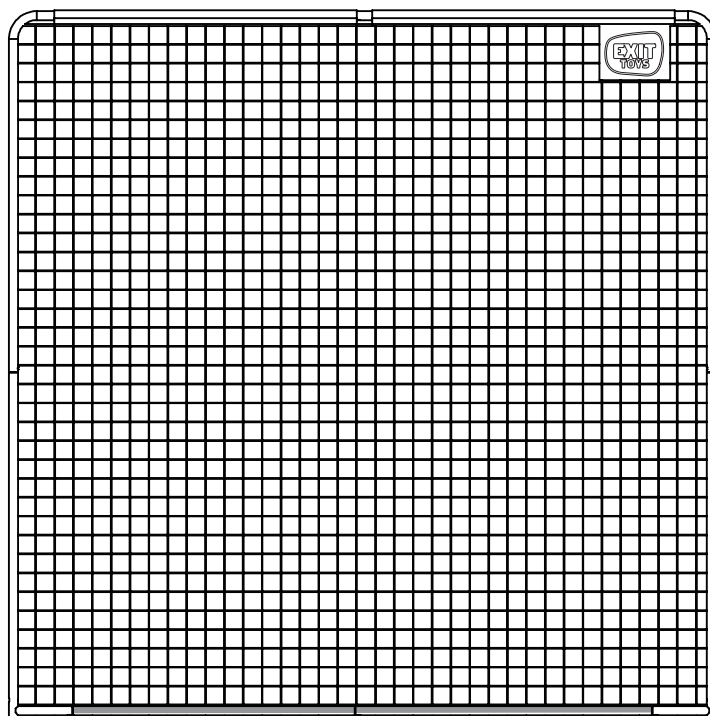

**6**

Part.Nr.	Qty
9	8

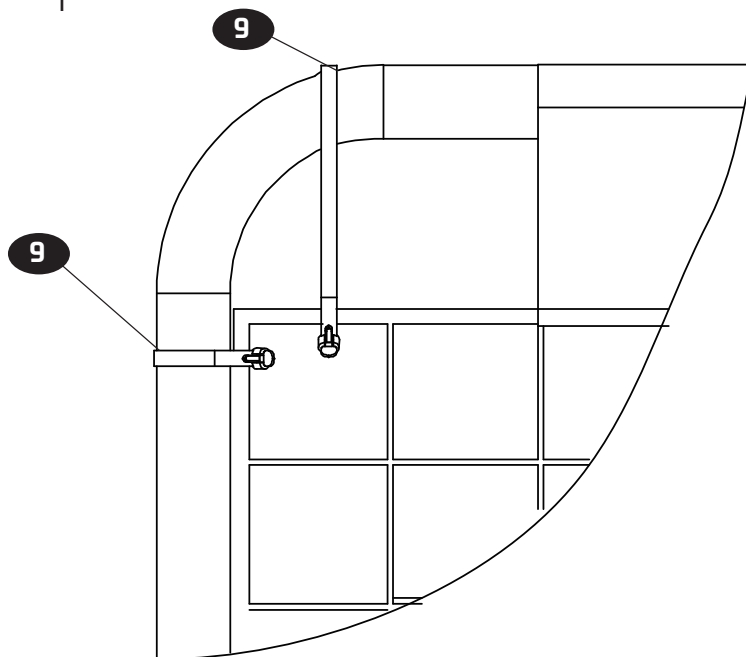
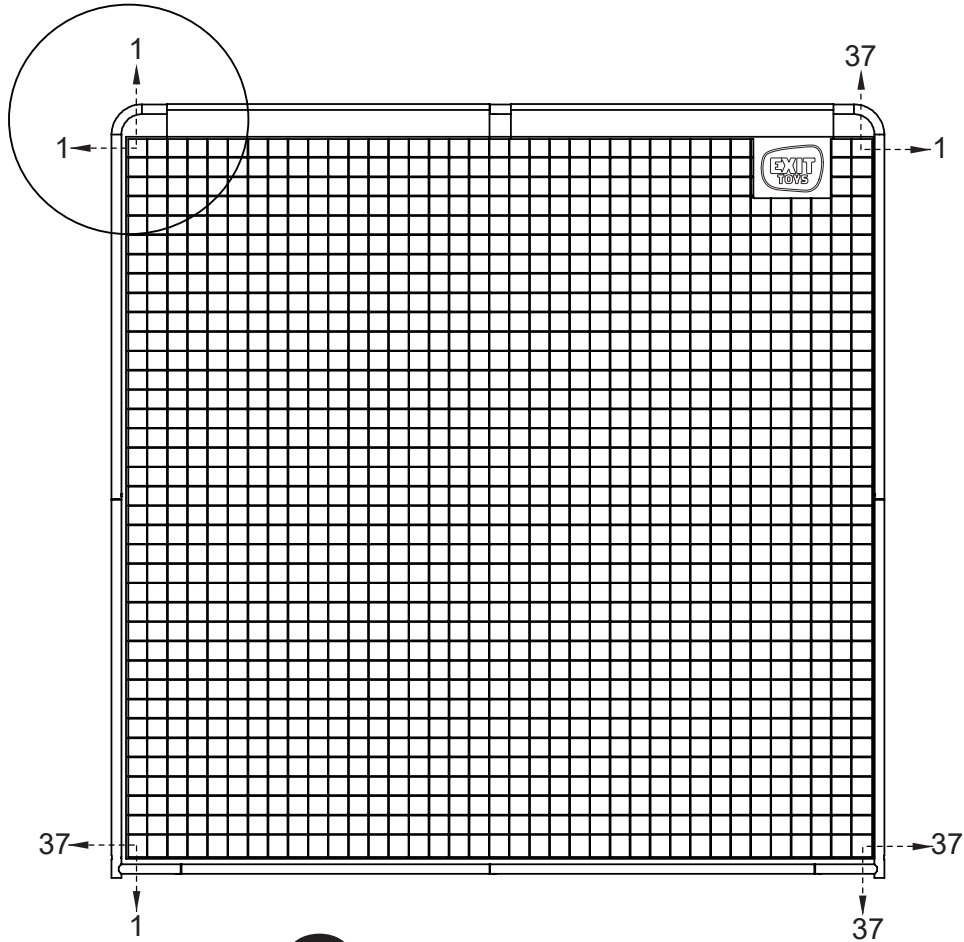





Part.Nr.	Qty
9	35

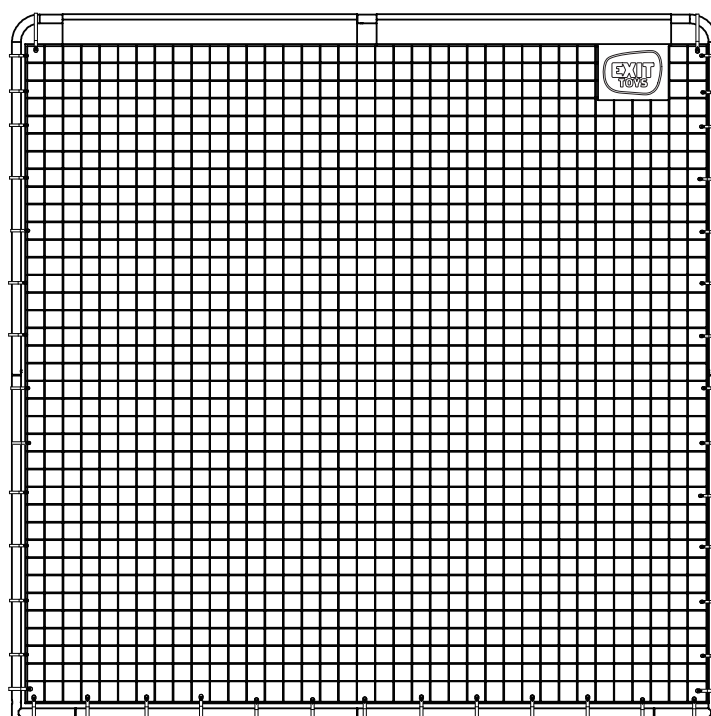
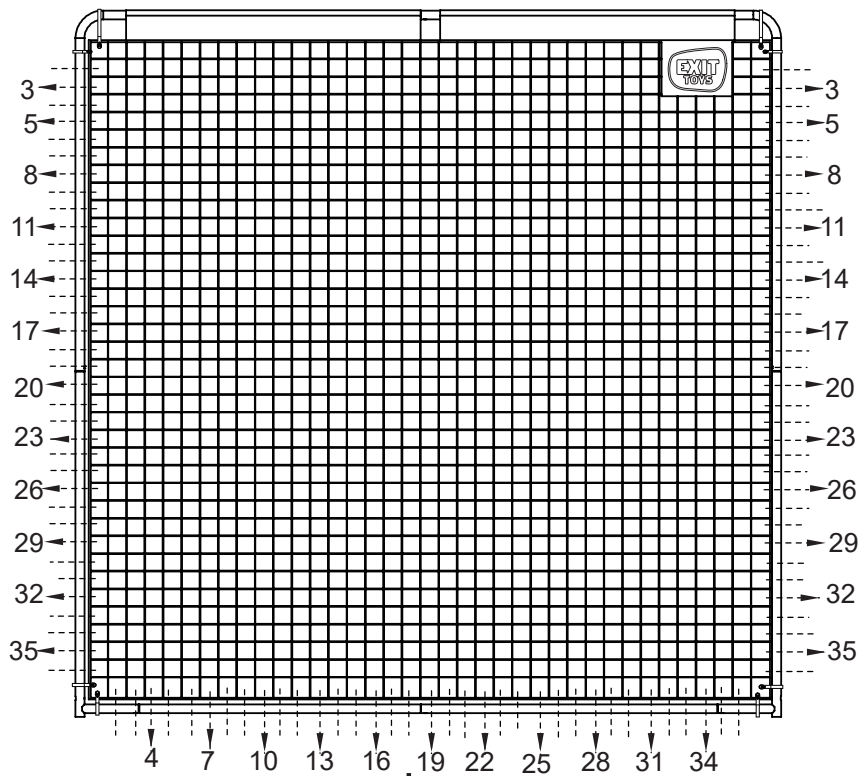

Part.Nr.	Qty
5	1

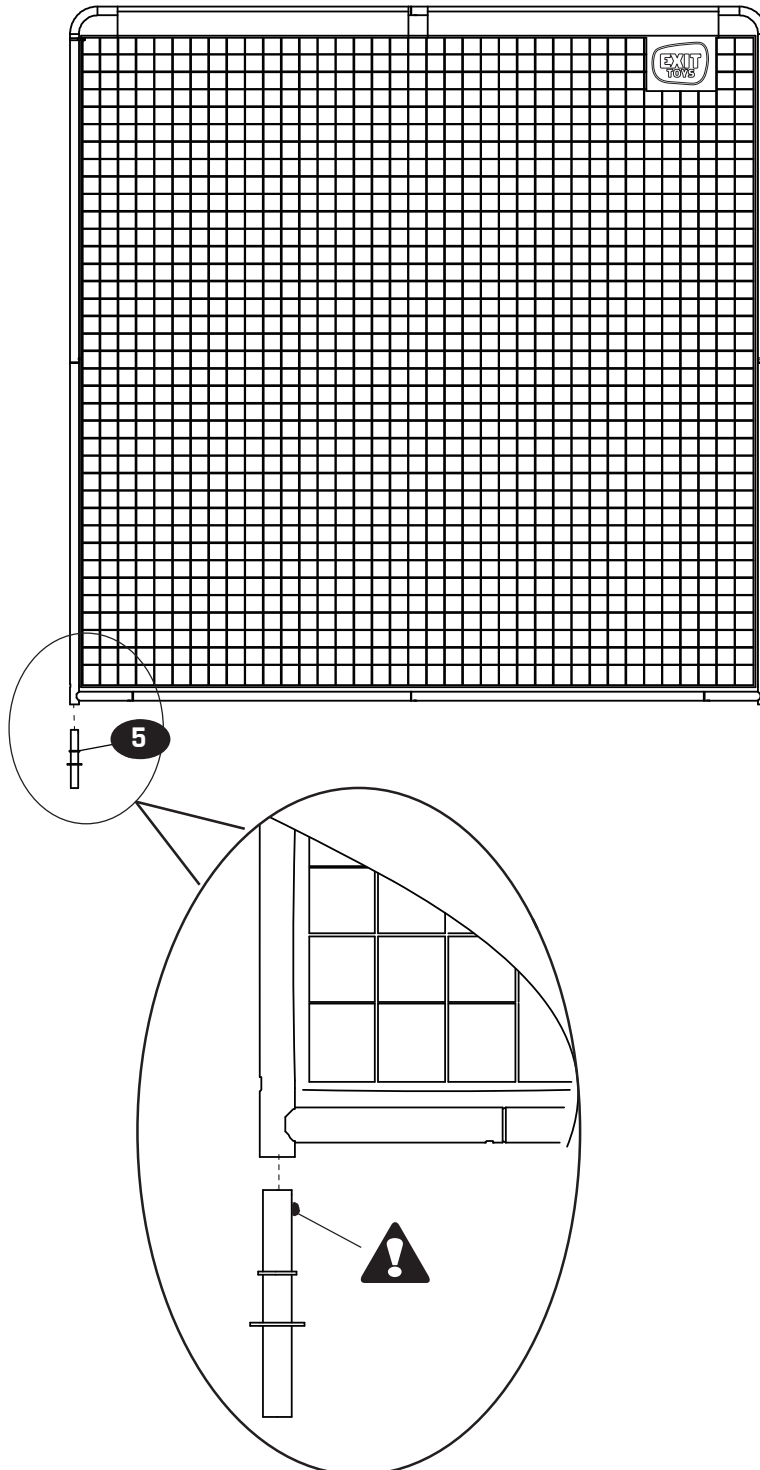

9

Part.Nr.	Qty
11	1

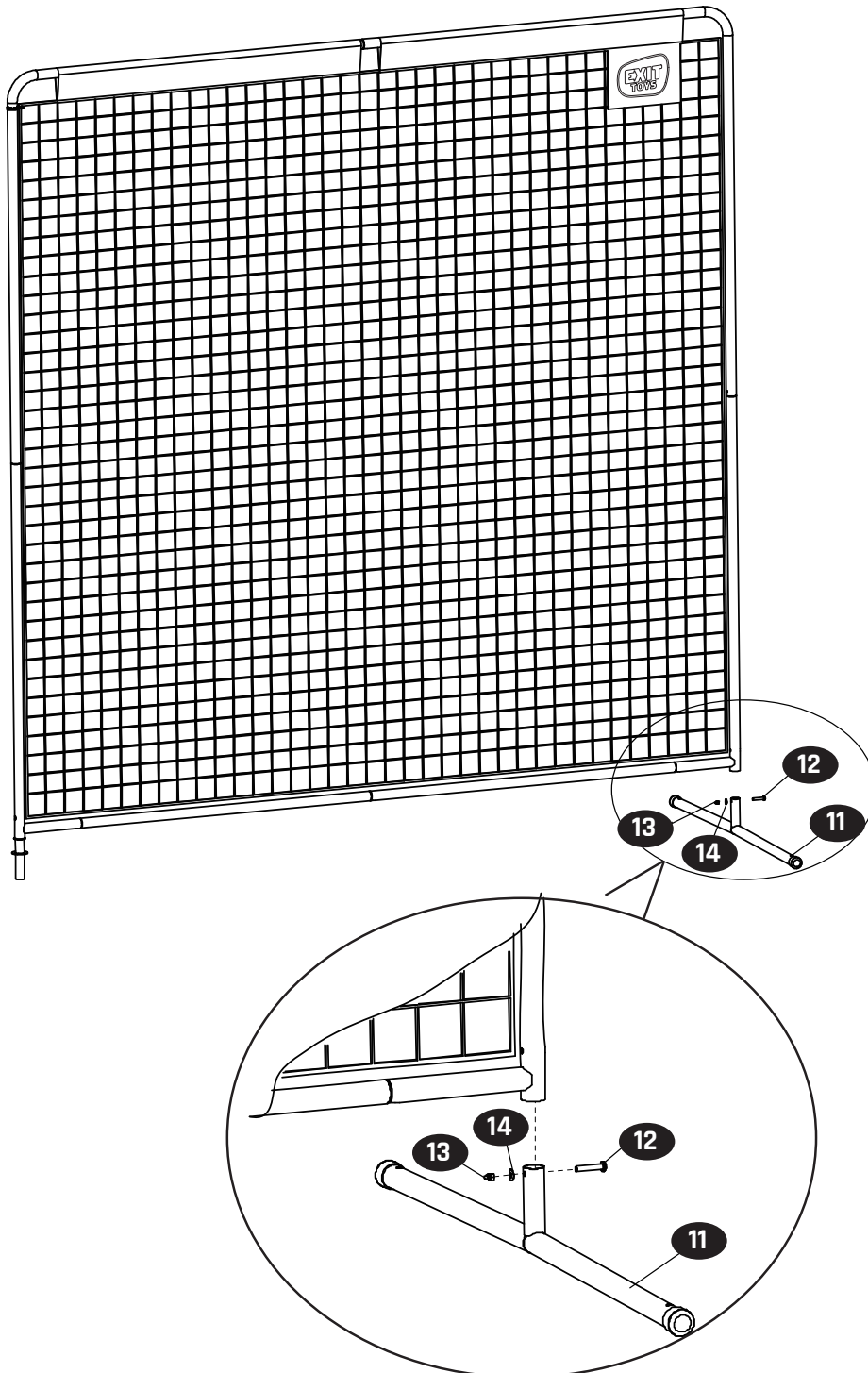
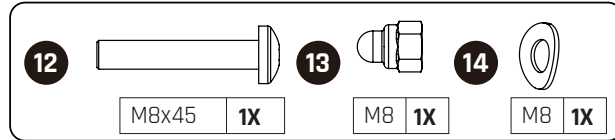

**10**

Part.Nr.	Qty
6	1

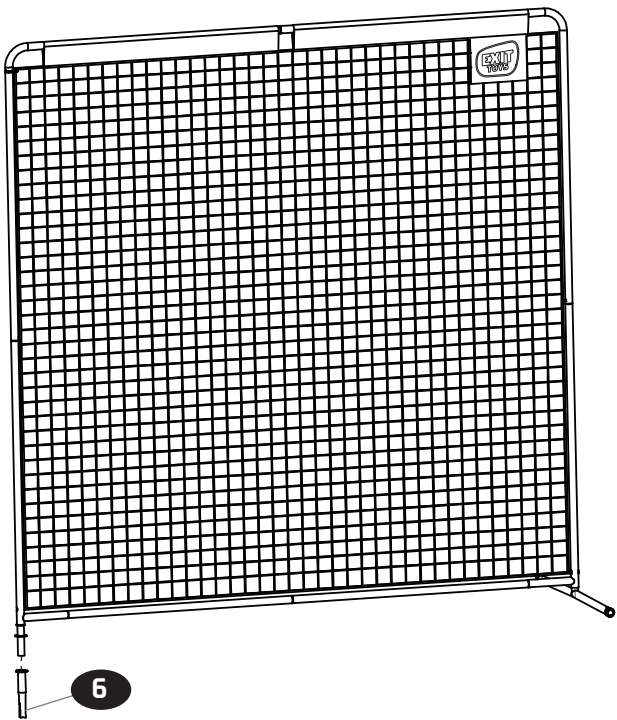
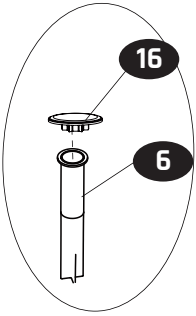
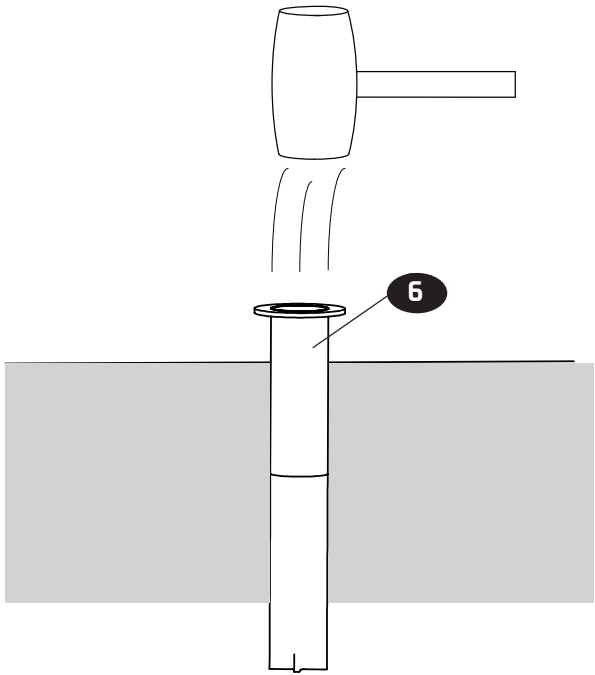

**11**

Part.Nr.	Qty
7	2

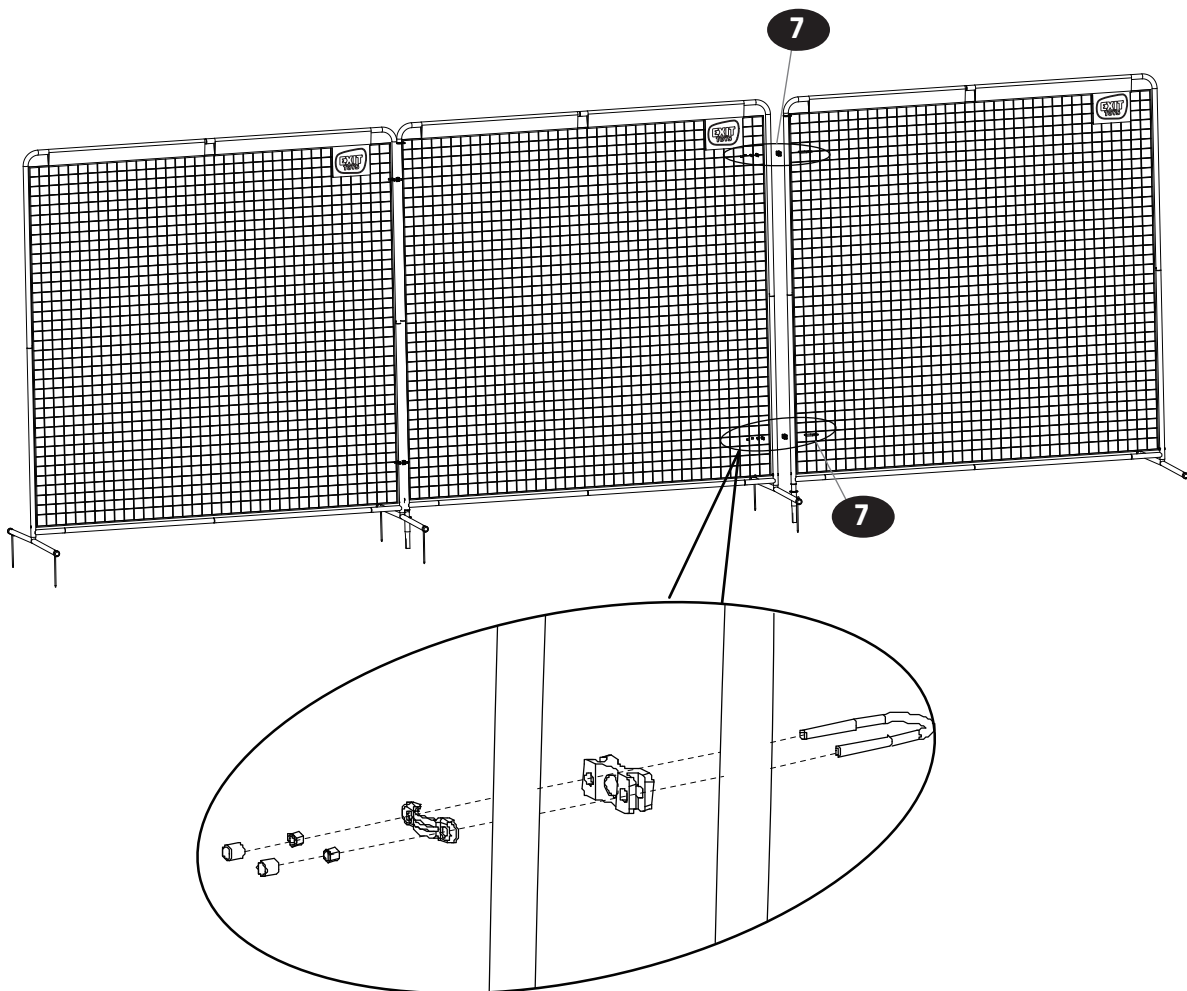

**12**

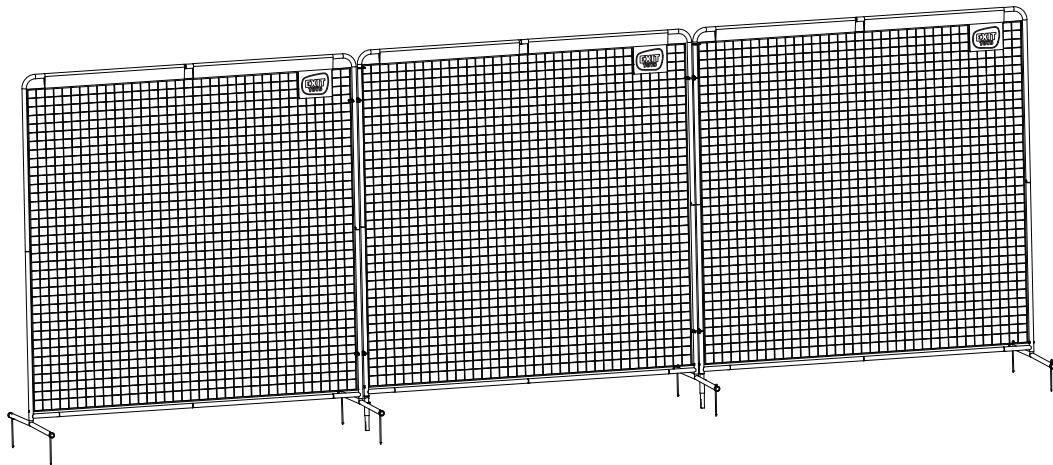
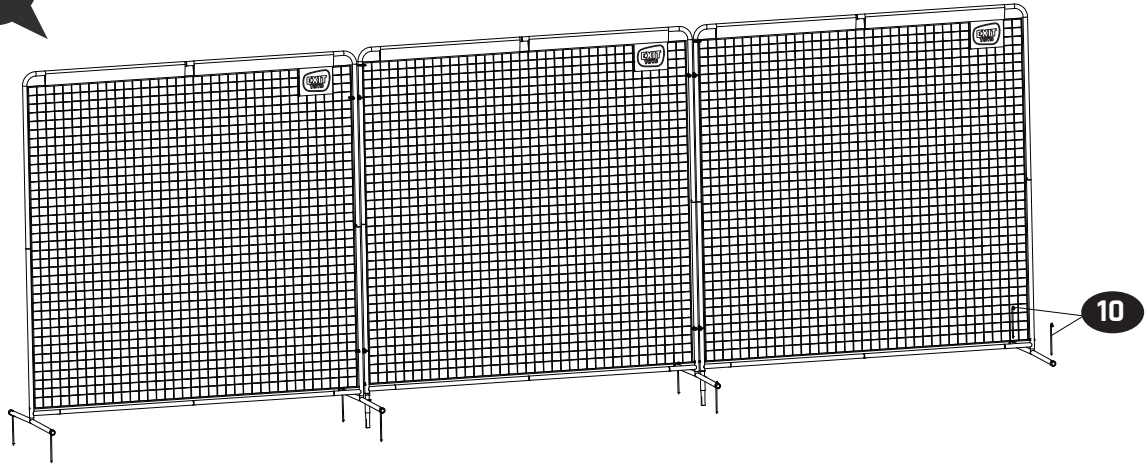

# Sports

EXIT Backstop Net 900



[www.exittoys.com](http://www.exittoys.com)

**Contact Information:**

Dutch Toys Group B.V.  
Edisonstraat 83  
7006 RB Doetinchem, The Netherlands

[info@exittoys.com](mailto:info@exittoys.com)  
[www.exittoys.com](http://www.exittoys.com)

EXIT Toys is part of:

**SIMBA · DICKIE · GROUP**

EXIT Toys is a registered trade mark of Dutch Toys Group